



GSL1系列剩余电流动作断路器

GSL1 Series Residual Current Operated Circuit-breaker

一、用途 (INTENDED USE)

- GSL1系列剩余电流动作断路器（以下简称断路器），是本公司采用先进设计、制造技术，研制、开发的新型断路器之一。其额定绝缘电压为800V，适用于交流50Hz，额定工作电压400V，额定工作电流至630A的电路中作不频繁转换及电动机不频繁起动之用。断路器具有过载、短路和欠电压保护功能，能保护线路和电源设备不受损坏，同时，可对人提供间接接触保护，还可以对过电流保护不能检测出的长期存在的接地故障可能引起的火灾危险提供保护。

GSL1 series residual current operated circuit -breaker(hereafter simply referred to as breakers) are one of the new type of breakers which have been developed by the company using advanced design and manufacturing technology. The rated insulation voltage of the breakers is 800V, suitable for turn-on of turn-off not frequently in the circuit of AC50Hz, rated working voltage 400V and rated working current up to 630A. The breakers equipment against damage may caused by long -term existed earth fault, which can't be examined by the over-current protection device.

- △ 断路器具有体积小、分断高、飞弧短，抗振动等特点。
The breakers have the following characteristics: compact size, high breaking capacity, short arc -over distance and shakeproof, etc.
- △ 断路器可垂直安装（即竖装），亦可水平安装（即横装）。
The breakers could be installed vertically (upring) or horizontally (transverse).
- △ 断路器不可倒进线，即只允许1、3、5接电源线，2、4、6接负载线。
The breakers can't be fed inversely, only allowing 1, 3, 5 connect with power supply wires, 2, 4, 6 connect with load wires.
- △ 断路器适用于隔离，符号表示为“ $\text{---} \text{I} \times \text{---}$ ”。
The breakers are applicable to isolation, its corresponding symbol is shown as “ $\text{---} \text{I} \times \text{---}$ ”.

- 断路器符合下列标准：

The breakers comply with the demands of the following standards;

- △ IEC60947-1及GB14048.1-2000 总则
IEC60947-1 and GB14048.1-2000 General
- △ IEC60947-2及GB14048.2-2001 低压断路器及附录B具有剩余电流保护的断路器
IEC60947-2 and GB14048.2-2001 Low voltage breakers and appendix B MCCB with residual current protection
- △ IEC60947-4-1及GB14048.4-2003 机电式接触器和电动机起动器
IEC60947-4-1 and GB14048.4-2003 Electro-mechanical contactors and motor starters
- △ 断路器获国家强制性产品认证“CCC”标志
The breakers acquired the "CCC" certificates approved by CQC (China Quality Certification Center)

二、型号及含义 TYPE AND ITS MEANING

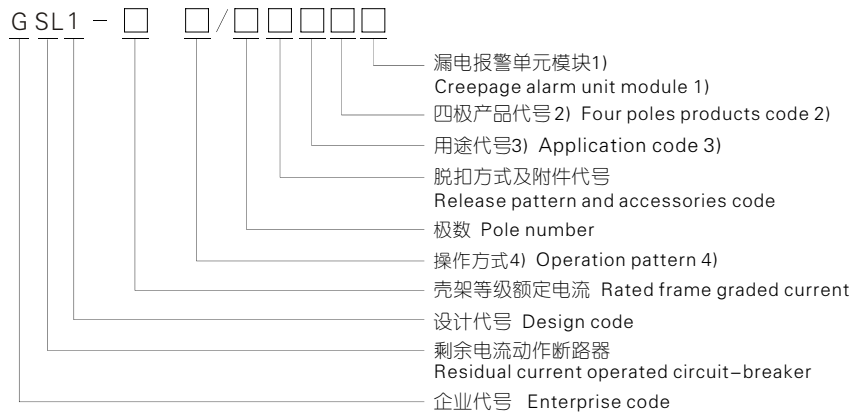

■ 注(Note):

1) 不带漏电报警单元模块无代号；带漏电报警单元模块并在工作方式一时用 I 表示；在工作方式二时用 II 表示；

No code for no creepage alarm unit module ; I for creepage alarm unit module under operation mod one , II for under operation mode two(particularly shown in p21)

2) 三极产品无代号；四极产品分A、B；

No code for three poles breakers.Four poles breakers are classified into A,B.

3) 配电用无代号；保护电机用以2表示；

No code for power distribution,2 means for motor protection.

4) 手柄直接操作无代号；电动操作用“P”表示；转动手柄操作用“Z”表示；

No code for operating directly with handle,p for power-driven and “Z ” for turning handle manually.

■ 按极数分为三极与四极。四极产品中中性极（N极）的形式分为两种：

According to the pole number of product,it is classifies into three poles and four poles。The neutral(N-pole) of the four-poles products has two types:

△ A型：N极不安装过电流脱扣元件，且N极始终接通，不与其它三极一起合分；

Type A: N-pole without over-current release unit, it has been connected all along,and dose not act with other three poles to turn on or off.

△ B型：N极不安装过电流脱扣元件，且N极与其它三极一起合分；（N极先合后分）

Type B:N-pole without over-current release unit,it could act wuth other three poles. (N-pole turns-on or turns-off) .

■ 按额定电流（A）分：GSL1-100为16, 20, 25, 32, 40, 50, 63, 80, 100九级；GSL1-225为100, 125, 140, 160, 180, 200, 225七级；GSL1-400为225, 250, 315, 350, 400五级；GSL1-630为400, 500, 630三级。

Classification according to rated current: GSL1-100 has nine grades:16, 20, 25, 32, 40, 50, 63, 80, 100A; GSL1-225 has seven: 100, 125, 140, 160, 180, 200, 225A; GSL1-400 has five: 225, 250, 315, 350, 400A; GSL1-630 has three :400, 500, 630A.

■ 按连接方式分为板前接线、板后接线和插入式接线几种方式。

The wiring method has the following ways wiring in front of the board, wiring on back of the board. insertion type of the board.

■ 按过电流脱扣器型式分为热动-电磁型（复式）、电磁型（瞬动）两种。

According to the over-current release pattern,it would be devided two types thermo-electrmagnetic (double) type and electromagnetic(insta-

- 按断路器是否带附件分带附件和不带附件两种：附件分为内部附件和外部附件：内部附件有分励脱扣器、欠电压脱扣器、漏电报警单元模块、辅助触头和报警触头五种；外部附件有转动手柄操作机构、电动操作机构。

According to the outfit, it also has two types: with or without outfit. The outfit include inner accessories have shunt release, under-voltage release, creepage alarm unit module auxiliary contacts and alarm contacts five kinds. The outside accessories are turning handle operation mechanism, power-driven operation mechanism.

三、适用工作环境及安装条件

APPLICATION CONDITIONS FOR OPERATION AND INSTALLATION

- △ 安装地点的海拔2000m及以下；周围介质温度不高于+40℃和不低于-5℃；且24小时平均值不超过35℃（特殊订货除外）；

Elevation of installation site: $\leq 2000\text{m}$; Ambient temperature: $-5^{\circ}\text{C} \sim +40^{\circ}\text{C}$, and average temperature in 24 hours below $+35^{\circ}\text{C}$ (except special ordering).

- △ 安装地点的空气相对湿度在最高温度为+40℃时不超过50%；在较低温度下可以有较高的相对湿度，例如20℃时达90%，对于温度变化偶尔产生的凝露应采取特殊的措施；

Relative humidity: not exceeding 50% at the maximum ambient temperature of $+40^{\circ}\text{C}$. With lower temperature higher humidity would be permitted, for example, reaches 90% at the dew on products surface due to temperature change.

- △ 污染等级为3级；Pollution protection :Grade 3.

- △ 断路器主电路的安装类别为Ⅲ，不接至主电路的辅助电路和控制电路，安装类别为Ⅱ；断路器应安装在无爆炸危险和无导电尘埃、无足以腐蚀金属和破坏绝缘的地方；

Installing categories: Ⅲ for breakers' main circuits; Ⅱ for auxiliary circuit and control circuit without connecting with main circuit. There must be not any explosive medium, and there must be not any gas which would destroy the insulation.

- △ 在没有雨雪侵袭的地方；

The place would not be invaded by rain and snow.

- △ 断路器应按产品的使用说明书安装。

The breaker should be installed according to stipulations in operations in operation manual.

四、主要特点 MAIN CHARACTERISTICS

- △ 剩余电流三相保护：GSL1断路器实现接地故障保护，常规的带剩余电流保护断路器的漏电保护模块工作电源取样为二相，本系列断路器为三相，若缺一相，断路器漏电保护模块仍能正常工作；

Residual current three-phase protection: GSL1 breakers have earth-fault protection. The creepage protection modules' operating power supply have been sampled two phases of the general MCCB with residual current protection. This series breakers are three phases, and the breakers' creepage protection module still normally operate if lacking of any one phase.

- △ 现场可调:额定剩余动作电流 $I_{\Delta n}$ 及剩余电流动作时间（非延时和延时）根据实际情况现场可调；

Locally adjustable : According to the actual situation, the rated residual

operating current $I\Delta n$ and residual current operating time(underlay and delay)can be locally adjusted.

- △ 低电压保护：当相电压降低至80V，漏电保护模块仍能正常工作；
Under-voltage protection:The creepage protection module still normally operate,even the phase voltage reduces to 80V.
- △ 具有漏电报警输出功能：当设备或线路的剩余电流，达到或超过设定值，带漏电报警单元模块的断路器输出一个无源接点信号，驱动相应的报警装置；
Creepage alarm output function:when the residual current of the equipment or wires reach or xceed the setting value,the breakers with creepage alarm unit module will output a passive contact signal, to drive corresponding alarm devices.
- △ 安装具有互换性：外形尺寸与GSM1系列断路器同规格相同（除GSL1-630），安装具有较好的互换性。

Interchangeable installation:the outline dimensions are the same specification as the GSM1 series breakers(except GSL1-630),and installation has better interchangeability.

五、结构简介 SYNOPSIS OF STRUCTURE



六、脱扣器方式及内部附件代号 RELEASE PATTERN AND ACCESSORIES CODE

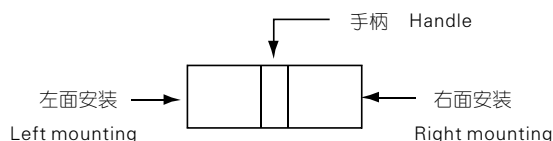

报警触头 Alarm contact
 辅助触头 Auxiliary contact
 欠压脱扣器 Under-voltage release
 分励脱扣器 Shunt release
 引线方向 Lead direction

表(Table) 1

脱扣器 方式及内 部附件代号 Release pattern and accessories	极数及N极型式 Pole number and N-pole type	附件名称 Accessories name	GSL1-100 GSL1-225		GSL1-400		GSL1-630	
			3极 Three poles 4极A型 Type A of four poles	4极B型 Type B of four poles	3极 Three poles 4极A型 Type A of four poles	4极B型 Type B of four poles	3极 Three poles 4极A型 Type A of four poles	4极B型 Type B of four poles
208,308	报警触头 Aalarm contact							
210,310	分励脱扣器 Aalarm contact							
220,320	辅助触头 Auxiliary contact							
230,330	欠电压脱扣器 Under voltage release							
240,340	分励脱扣器 辅助触头 Shunt release Auxiliary contact		—		—		—	
228,328	分励脱扣器 报警触头 Shunt release Aalarm contact		—		—		—	
228,328	辅助触头 报警触头 Aalarm contact Aalarm contact							

■ 注(Note):

△ 脱扣器凡是及内部附件代号首位数字2表示电磁（瞬时）脱扣器，3表示热动—电磁（复式）脱扣器；后两位数值表示内部附件代号，如无附件则用00表示。
Release pattern and accessories codes' premier number 2 frelectromagnetic (instantaneous)release pattern,3 for thermo–electromagnetic(double) release pattern.Last two numbers stand for accessories code,two zero accessories code.

七、主要技术指标 MAIN TECHNICAL PARAMETER

■ 技术性能指标 The technical-performance

表(Table) 2

型号 Type	GSL1-100	GSL1-225	GSL1-400	GSL1-630	
壳架电流Inm(A) Frame Current Inm	100	225	400	630	
额定电流In(A) Rated Current In	16, 20, 25, 32, 40, 50, 63, 80, 100	100, 125, 140, 160, 180, 200, 225	225, 250, 315, 350, 400	400, 500, 630	
极数 Pole Number	3 4	3 4	3 4	3 4	
额定绝缘电压Ui(V) Rated Insulation Voltage Ui	AC800				
额定工作电压Ui(V) Rated operation Voltage Ui	Ac400				
额定冲击耐受电压Uimp(V) Rated impulse Withstand Voltage	8000				
飞弧距离(mm) Arc-over Distance	≤50		≤100		
极限短路分断能力Icu(kA) Limiting Short-circuit Breaking Ability Icu	AC400V 50		65		
运行短路分断能力Ics(kA) Operating Short-circuit Breaking Ability Ics	AC400V 35		42		
额定剩余动作电流 IΔn(mA) Rated residual Working Current	延时型 delay 30/300/500		100/300/500/10000 100/300/500/10000		
	非延时型 undelay 30/300/500		100/300/500/10000 100/300/500/10000		
额定剩余不动作电流 IΔno(mA) Rated residual Non-acting Current	$\frac{1}{2} I\Delta n$				
额定剩余短路接通(分断)能力 IΔm(kA) Rated residual Short-circuit Connecting (Breaking)Ability	$\frac{1}{4} Icu$				
操作性能(次) Operation Performance (time)	电气寿命 Electronic life	1500	1000	1000	1000
	机械寿命 Mechanica life	8500	7000	7000	7000

表(Table) 3

外形尺寸(mm) Outline Dimensions	W		L		H		H		H	
	92	22	107	142	150	198	210	280	280	280
	150	50	165	165	257	257	280	280	280	280
分励脱扣器 Shunt release	○	○	○	○	○	○	○	○	○	○
欠电压脱扣器 Under voltage release	○	○	○	○	○	○	○	○	○	○
漏电报警单元模块 Creepage alarm unit module	○	○	○	○	○	○	○	○	○	○
辅助触头 Auxiliary contact	○	○	○	○	○	○	○	○	○	○
报警触头 Alarm contact	○	○	○	○	○	○	○	○	○	○
电动操作机构 Power-driver mechanism	○	○	○	○	○	○	○	○	○	○
转动手柄操作机构 Turning Handle Operation Mechanism	○	○	○	○	○	○	○	○	○	○

■ 注(Note):

- △ 极限分断与飞弧距离包含横装与竖装;
Limiting breaking and arc-over distance can be vertically and horizontally installed.
- △ 本系列三极断路器接三相负载时, 负载不能带中性线, 否则该断路器会产生误动作;
The load can't have neutral wire, including the power supply of the load monitor circuit from the breaker's load terminals, when this series three phases breakers connecting with three-phases load, or the breakers will be misoperation.
- △ 本系列三极断路器接单相负载时, 相线接A极, 中性线接C极, 不要接B极。
When this series three-poles breakers connecting with single phase load, the phase wire connects with A pole, and neutral wire connects with C pole, with B pole empty.
- △ 剩余电流保护动作时间 Working time of the residual current protection

表(Table) 4

剩余电流 Residual current		$I\Delta n$	$2I\Delta n$	$5I\Delta n$	$10I\Delta n$
非延时型 undelay	最大断开时间 (s) Maximum breaking time	0.2	0.1	0.04	0.04
延时型 delay	最大断开时间 (s) Maximum breaking time	0.25/0.9/1.9	0.25/0.9/1.9	0.25/0.9/1.9	0.25/0.9/1.9
	极限不驱动时间 Δt (s) Limiting undrived time	—	0.1/0.5/1	—	—

八、功率损耗及降容系数 POWER WASTAGE AND CAPACITY-REDUCING FACTOR

■ 功率损耗 Power wastage

表(Table) 5

型号 Type	通电流(A) Electromotio current	三相总功率损耗(VA) The total power wastage of three phase	
		板前、板后接线 Wiring in front or on back of the board	插入式接线 insert type wiring
GSL1-100	100	35	40
GSL1-225	225	62	70
GSL1-400	400	115	125
GSL1-630	630	187	200

九、环境温度变化的降容系数 CAPACITY-REDUCING FACTOR OF AMBIENT TEMPERATURE CHANGE

表(Table) 6

型号 Type	环境温度 temperature				
	+40°C	+45°C	+50°C	+55°C	+60°C
GSL1-100	1In	0.95In	0.89In	0.84In	0.76In
GSL1-225	1In	0.96In	0.91In	0.87In	0.82In
GSL1-400	1In	0.94In	0.87In	0.81In	0.73In
GSL1-630	1In	0.93In	0.88In	0.83In	0.76In

十、保护特性 PROTECTION FEATURE

断路器热动型脱扣器具有反时限特性；电磁脱扣器为瞬时动作。

The thermodynamic release of a circuit breaker provides the feature of inverse time-delay, while the magnetic release feature of instantaneous operation as shown on table.

△ 配电用 For Power Distribution

表(Table) 7

脱扣器额定电流 (A) Rated current of release (A)	热动型脱扣器(环境温度+40°C) Thermodynamic release(ambient temp +40°C)		电磁脱扣器 动作电流(A) Electromagnetic release acting current
	1.05In(冷态)动作时间(h) 1.05In(Cold state) Acting time	1.30In(热态)动作时间(h) 1.30In(Heat state) Acting time	
16 ≤ In ≤ 63	1小时内不动作 Not acting within one hour	≤1h动作Acting	10In ± 20%
63 ≤ In ≤ 125	2小时内不动作 Not acting within one hour	≤2h动作Acting	
125 ≤ In ≤ 630	2小时内不动作 Not acting within one hour	≤2h动作Acting	5In ± 20% 10In ± 20%

△ 保护电动机用 For motor protection

表(Table) 8

脱扣器额定电流 (A) Rated current of release (A)	热动型脱扣器(环境温度+40°C) Thermodynamic release(ambient temp +40°C)				电磁脱扣器 动作电流(A) Electromagnetic release acting current
	1.05In(冷态)动作时间(h) 1.05In(Cold state) Acting time	1.20In(热态)动作时间(h) 1.20In(Heat state) Acting time	1.50In(热态)动作时间(h) 1.50In(Heat state) Acting time	7.21In(冷态)动作时间(h) 7.21In(Cold state) Acting time	
16 ≤ In ≤ 630	2小时内不动作 Not acting within one hour	≤2h动作 acting	8min	6s ≤ Tp ≤ 20s	12In ± 20%

十一、断路器特性曲线 CHARACTERISTIC CURVE OF THE BREAKER

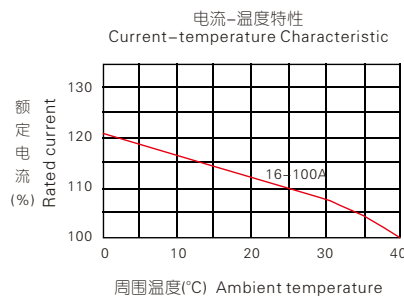

△ GSL1-100时间/电流特性曲线(配电)
GSL1-100Time/Current characteristic
curve(power distribution)

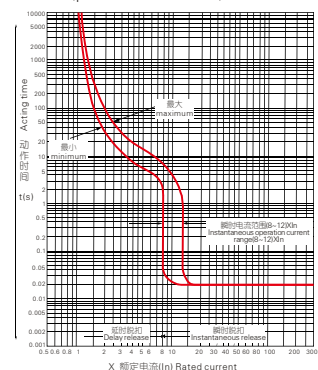

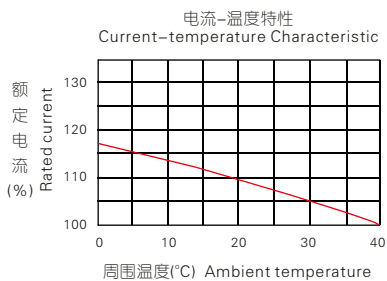

△ GSL1-225时间/电流特性曲线（配电）
GSL1-225Time/Current characteristic curve(power distribution)

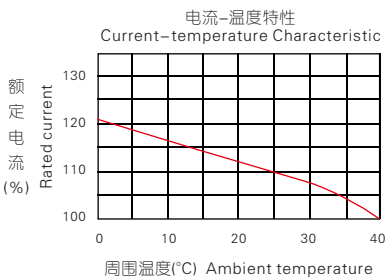
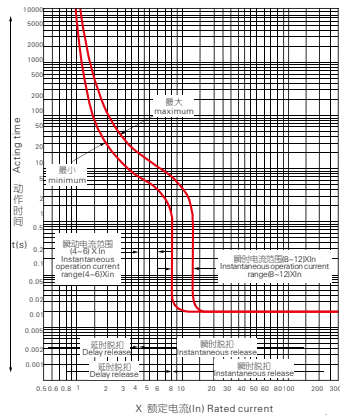

△ GSL1-400时间/电流特性曲线（配电）
GSL1-400Time/Current characteristic curve(power distribution)

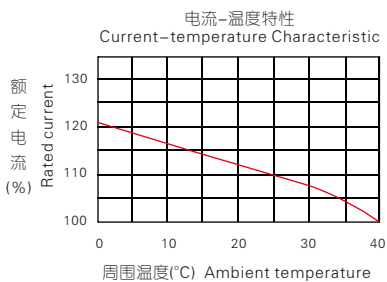
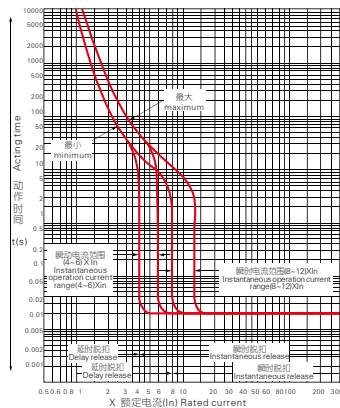

△ GSL1-630时间/电流特性曲线（配电）
GSL1-630Time/Current characteristic curve(power distribution)

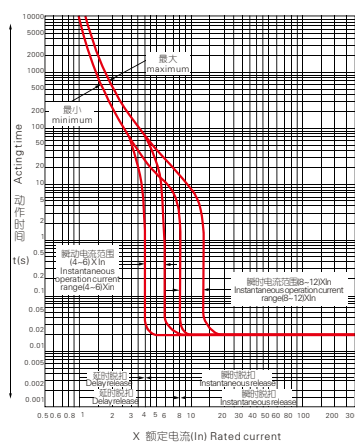

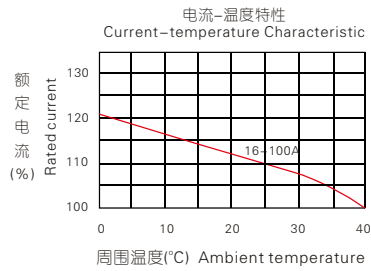

△ GSL1-100时间/电流特性曲线 (电动机)
GSL1-100Time/Current characteristic curve (power distribution)

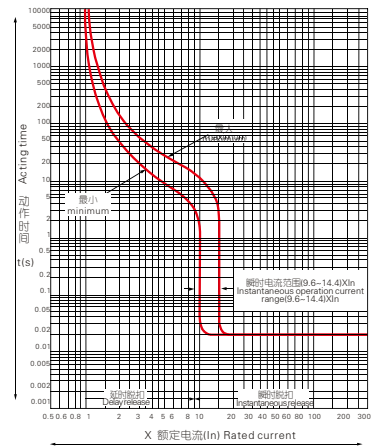

△ GSL1-225时间/电流特性曲线 (电动机)
GSL1-225Time/Current characteristic curve (power distribution)

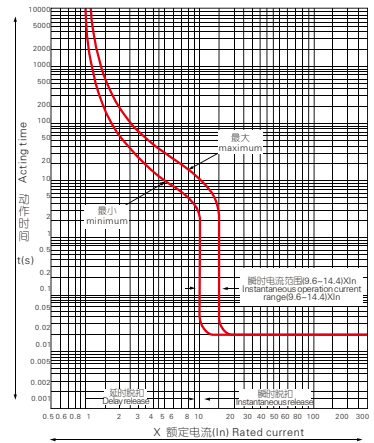

△ GSL1-400时间/电流特性曲线 (电动机)
GSL1-400Time/Current characteristic curve (power distribution)

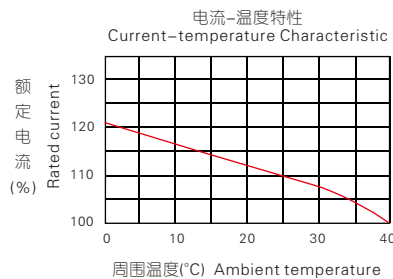
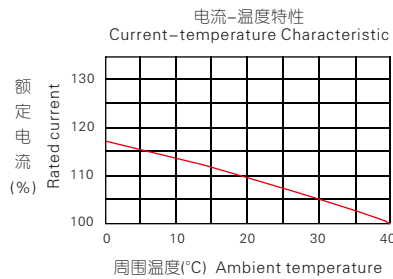
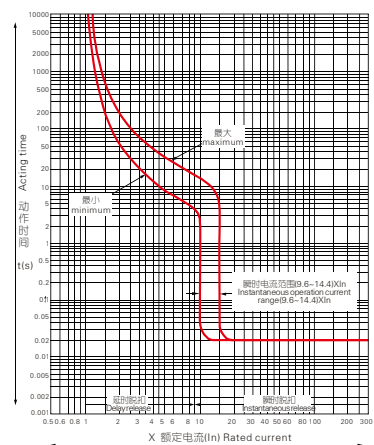

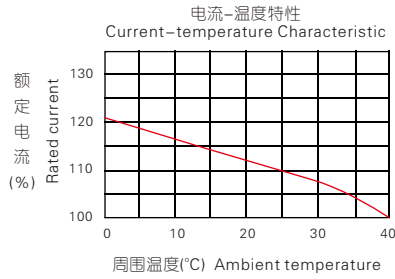

△ GSL1-630时间/电流特性曲线(电动机)
GSL1-630Time/Current characteristic curve(power distribution)

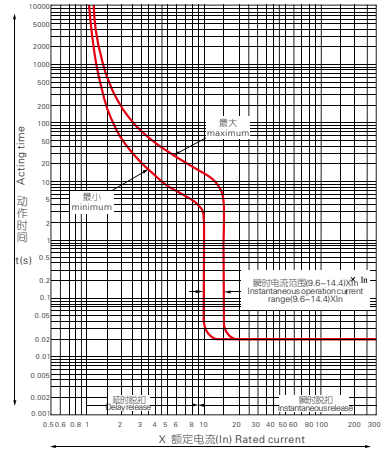

十二、剩余电流保护特性曲线 RESIDUAL CURRENT PROTECTI ON CHARACTERI STIC CURVE

△ IΔn=0.03/0.1/0.3/0.5/1(A)

非延时型剩余电流保护时间/电流特性曲线
Time/current characteristic curve of the undelay residual current protection

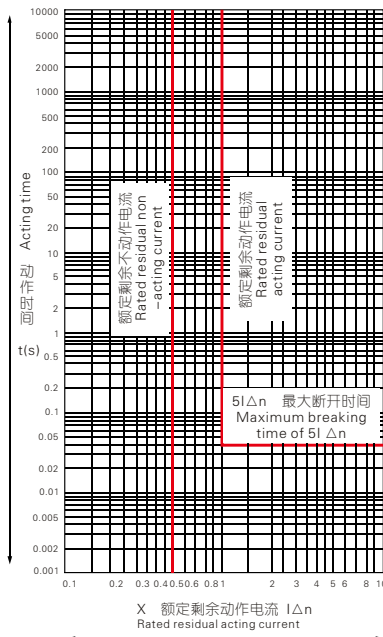

△ IΔn=0.1/0.3/0.5/1(A)

延时型剩余电流保护时间/电流特性曲线
Time/current characteristic curve of the delay residual current protection

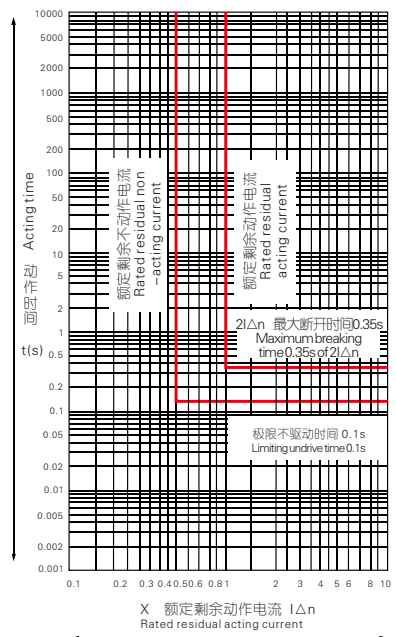

△ $I\Delta n=0.1/0.3/0.5/1(A)$

延时型剩余电流保护时间/电流特性曲线
Time/current characteristic curve of the delay residual current protection

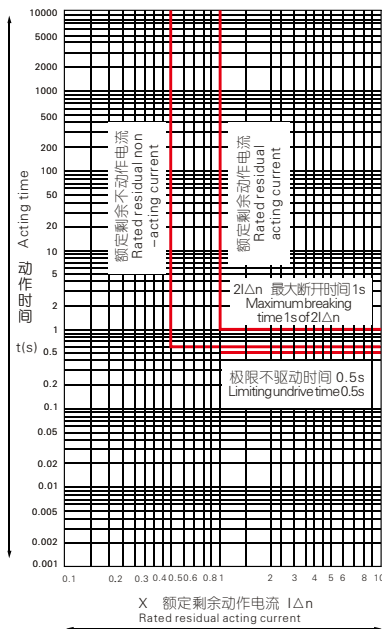

△ $I\Delta n=0.1/0.3/0.5/1(A)$

延时型剩余电流保护时间/电流特性曲线
Time/current characteristic curve of the delay residual current protection

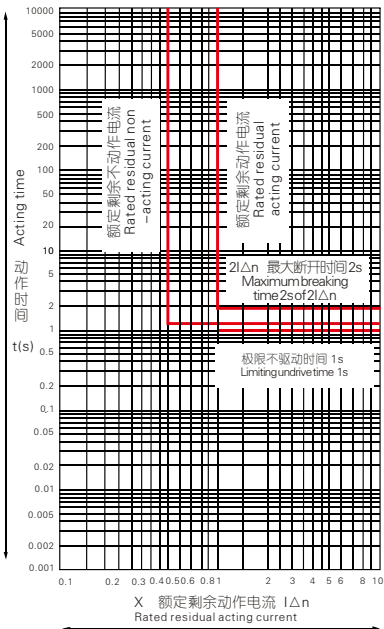

十三、外型及安装尺寸

OUTLINE DIMENSIONS AND MOUNTING DIMENSIONS

△ GSL1-100三极、GSL1-100四极板前接线

Wiring in front of the board (GSL1-100, three poles and GSL1-100 four poles)

X—X、Y—Y为三极断路器中心 X-X、Y-Y as the center of the breaker(three poles)

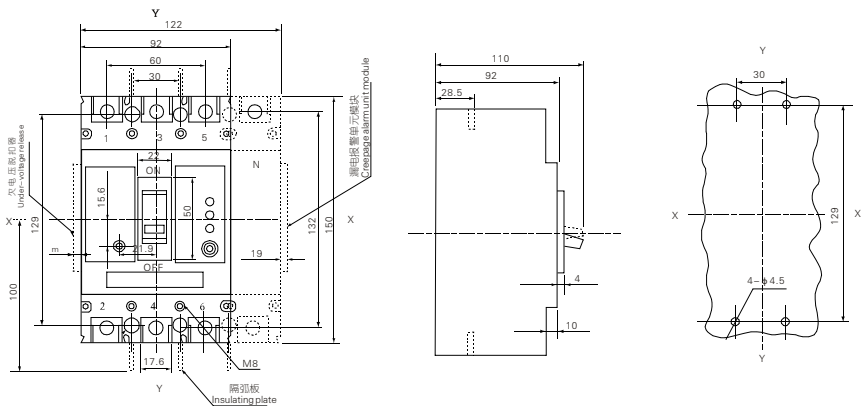

欠电压脱扣器厚度: $m=21\text{mm}$
The thickness of under-voltage release: $m=21$

板前接线安外形和装板尺寸
Outline dimensions and mounting dimensions, wiring in front of the board

板前接线安装板开孔尺寸
Aperture dimensions of the sub-panel, wiring in front of the board

△ GSL1-100三极、GSL1-100四极板后接线

Wiring in back of the board (GSL1-100, three poles and GSL1-100 four poles)

X—X、Y—Y为三极断路器中心 X-X、Y-Y as the center of the breaker (three poles)

△ GSL1-225三极、GSL1-225四极板后接线

Wiring on back of the board (GSL1-225, three poles and GSL1-225 four poles)
X-X、Y-Y为三极断路器中心 X-X、Y-Y as the center of the breaker(three poles)

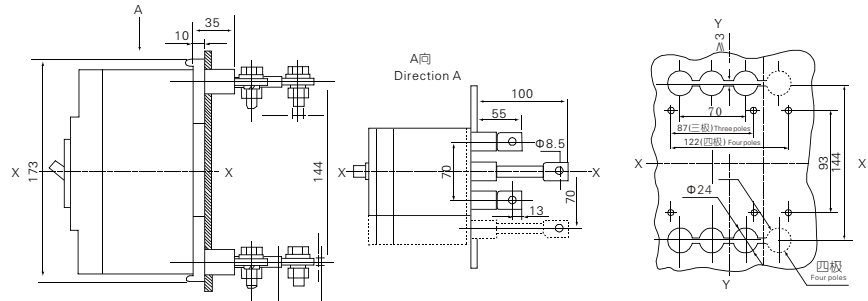

板后接线外形和安装尺寸
Outline dimensions and mounting dimensions,
wiring on back of the board

板后接线安装板开孔尺寸
Aperture dimensions of the sub-
panel, wiring on back of the board

△ GSL1-225三极、GSL1-225四极插入式接线

Insertion type wiring of the board (GSL1-225, three poles and GSL1-225 four poles)
X-X、Y-Y为三极断路器中心 X-X、Y-Y as the center of the breaker(three poles)

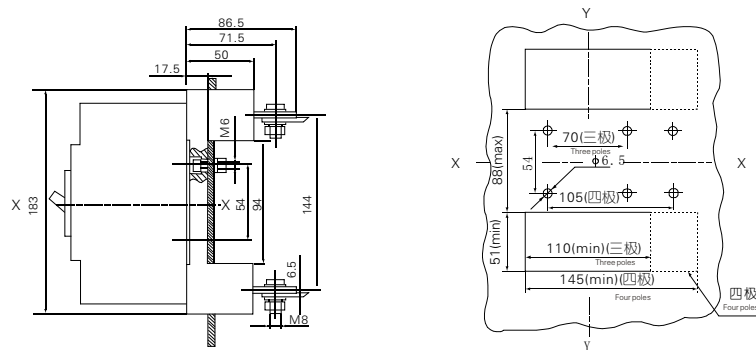

插入式接线外形和安装尺寸
Outline dimensions and mounting dim-
ensions, wiring by insertion of the board

插入式接线安装板开孔尺寸
Aperture dimensions of the sub-panel,
wiring on insertion of the board

△ GSL1-400三极、GSL1-400四极板前接线

Wiring in front of the board (GSL1-400, three poles and GSL1-400 four poles)
X-X、Y-Y为三极断路器中心 X-X、Y-Y as the center of the breaker(three poles)

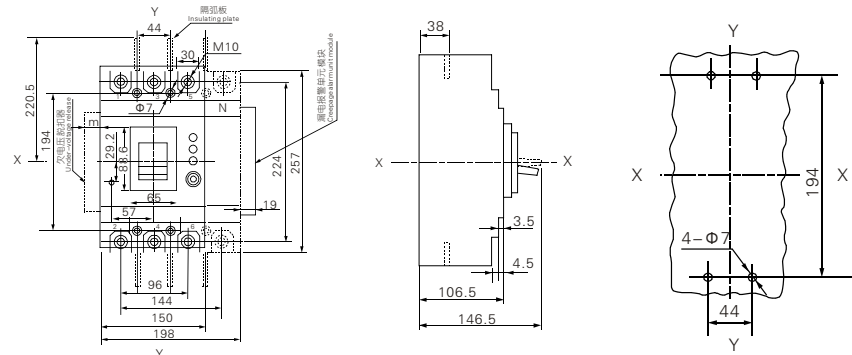

欠电压脱扣器厚度: m=21mm
The thickness of under-voltage
release: m=21

板前接线外形和安装尺寸
Outline dimensions and mount-
ing dimensions, wiring in front of
the board

板前接线安装板开孔尺寸
Aperture dimensions of the
sub-panel, wiring in front of
the board

△ GSL1-630三极、GSL1-630四极板后接线

Wiring on back of the board (GSL1-630, three poles and GSL1-630 four poles)

X-X、Y-Y为三极断路器中心 X-X、Y-Y as the center of the breaker(three poles)

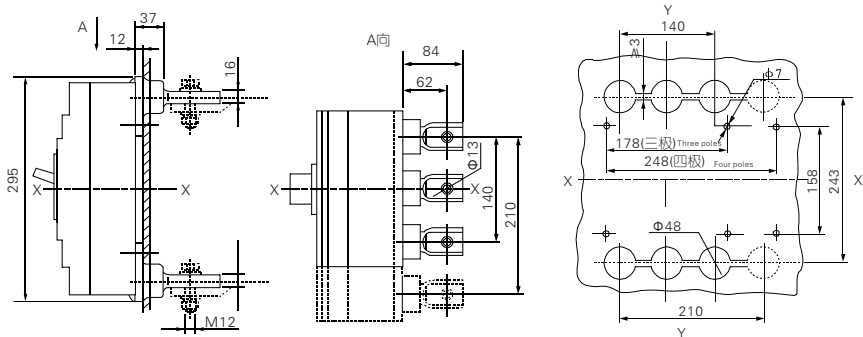

板后接线外形和安装尺寸

Outline dimensions and mounting dimensions, wiring on back of the board

板后接线安装板开孔尺寸

Aperture dimensions of the sub-panel, wiring on back of the board

△ GSL1-630三极、GSL1-630四极插入式接线

Insertion type wiring of the board (GSL1-630, three poles and GSL1-630 four poles)

X-X、Y-Y为三极断路器中心 X-X、Y-Y as the center of the breaker(three poles)

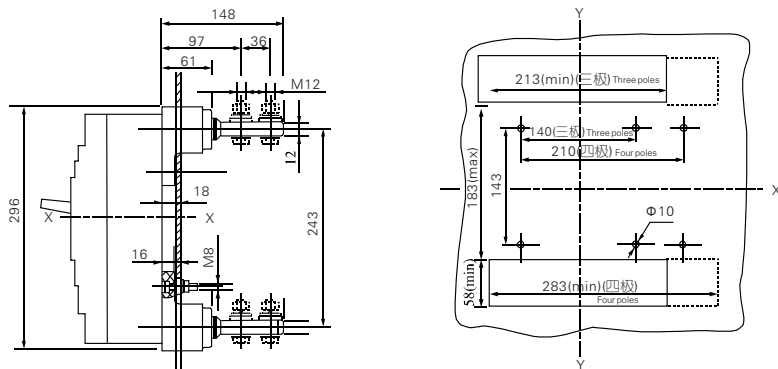

插入式接线外形和安装尺寸

Outline dimensions and mounting dimensions, wiring by insertion of the board

插入式接线安装板开孔尺寸

Aperture dimensions of the sub-panel, wiring on insertion of the board

十四、内外部附件 INTERNAL/EXTERNAL ACCESSORIES

■ 断路器的内部附件 The internal accessories of the breaker

△ 根据用户需要断路器附件可直接导线引出，或加装接线端子排。

According to user's demands, accessories could lead to direct wire outcoming or flat terminals could be added.

■ 欠电压脱扣器 Under-voltage release

△ 电压规格: AC50Hz 230V、400V。

Voltage specification :AC50Hz 230V、400V.

△ 外挂欠电压模块接线图(虚框内为断路器内部附件接线图)

Wiring diagram of the under-voltage module connected externally(inner accessories are indicated in the dotted square)

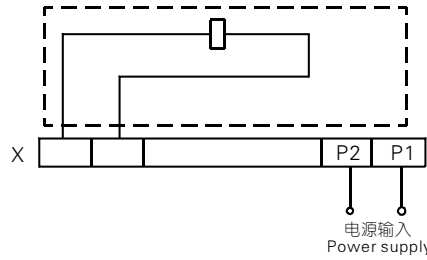

符号说明: X为接线端子排
Code description:
"X"stands for flat terminals

△ 欠电压脱扣器功率 Power of the under-voltage release see Table

配电断路器 Fitting breaker	欠电压脱扣器功率(VA) Power of the under-voltage release	
	AC230V	AC400V
GSL1 - 100	2 . 6	3 . 3
GSL1 - 225	3 . 8	3 . 3
GSL1 - 400	3 . 7	2 . 7
GSL1 - 630	2 . 5	2 . 8

- △ 在额定工作电压的35%~70%时, 欠电压脱扣器应可靠使断路器脱扣;
Under the voltage of 35% ~ 70% of the rated voltage, the under-voltage release should make the breaker trip correctly.
- △ 在额定工作电压的85%~110%时, 欠电压脱扣器应保证断路器合闸;
Under the voltage of 85% ~ 110% of the rated voltage, the under-voltage release should make the breaker close reliably.
- △ 在额定工作电压低于35%时, 欠电压脱扣器应防止断路器合闸。
In case of the operation voltage less than 35% of the rated voltage, the under-voltage should prevent the breaker from closing.
- △ 警告: 欠电压脱扣器必须先通电, 断路器才能再扣及合闸。否则将损坏断路器!
Warning: Only the under-voltage release energized in advance the breaker could be recramped and closed, otherwise the breaker will be damaged.

■ 分励脱扣器 Shunt release

△ 接线图 (虚框内为断路器内部附件接线图)

Scheme of wiring (the internal accessories in the dotted frame)

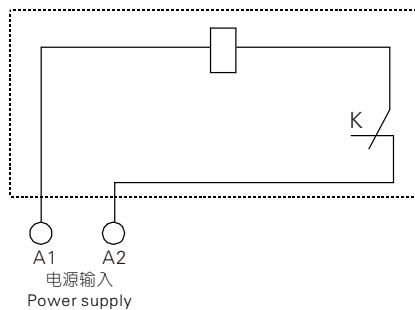

K: 分励脱扣器内部与线圈串联的微动开关为常闭触头, 当断路器分闸后, 该触头自行断开, 合闸时闭合。

"K" is the show motion switch normal-close contact connected the coil in series in the shunt release. It turns-on or turns-off voluntarily as soon as the breaker on or off.

△ 电压规格：AC50Hz 230V或400V;DC220V在额定控制电源电压的70~110%之间时，分励脱扣器应可靠使断路器脱扣。

Voltage rating :AC50Hz 230V、400V、DC220V。The shunt release should make the breaker trip reliably when the operation voltage is 70%~110% of the rated control voltage.

■ 漏电报警单元模块 Creepage alarm unit module

漏电报警单元模块有两种方式，用户根据需要可在订货时说明：

Creepage alarm unit module has two patterns users can illuminate when ordering.

△ 方式一（用 I 表示）：当发生漏电，漏电报警模块发出信号，同时断路器脱扣；
Pattern one(as I):Creepage alarm unit module send out signals when creepage, meanwhile the breaker release.

△ 方式二（用 II 表示）：当发生漏电，漏电报警模块发出信号，但断路器不脱扣。
Pattern two(as II):Creepage alarm unit module send out signals when creepage but the breaker don't release.

△ 注：方式二是为满足特殊场合需要，用户在采用此功能保护电器时请慎重考虑。
Note:Pattern two fits for special situation, please carefully consideratie when using this protection electric products.

△ 接线图（虚框内为漏电报警模块内部附件接线图）

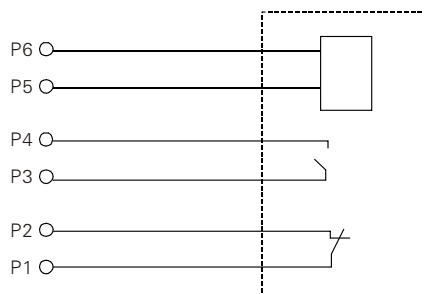

△ 规格：P5–P6端输入电源为AC50Hz 230V或400V。P1–P2、P3–P4触头容量为AC230 5A。

Specification: The input power supply of terminal P5–P6 is AC50Hz 230V or 400V. The contacts capacity of P1–P2 P3–P4 is AC230V 5A.

■ 报警触头 Alarm contact

断路器处于“分”“合”时的位置 The position of the breaker in "off" or "on"	B14 ———— B12 ————	B11 ———— B11 ————
断路器处于“自由脱扣”(报警)时的位置 The position of the breaker in "free release"(alarm)	B11、B14由断开状态转为接通状态 B11、B12由接通状态转为断开状态 Status of B11 and B14 switch from "open" to "close" Status of B11 and B12 switch from "close" to "open"	

■ 辅助触头 Auxiliary contact

断路器处于“分”时的位置 When the breaker in "off"	F14 ———— F12 ————	F11 ———— F21 ————	壳架等级电流400A及以上断路器 For the breaker with frame current 400A and above
	F14 ———— F12 ————	F11 ————	
断路器处于“合”时的位置 When the breaker in "on"	“分”时接通状态的触头转为断开状态 “分”时断开状态的触头转为接通状态 When the breaker is in "on", the contacts switch from "close" to "open" When the breaker is in "off", the contacts switch from "open" to "close"		

△ 辅助触头、报警触头额定电流 Rated current of the auxiliary contact, alarm contact

分类 Type	壳架等级额定电流 Inm(A) Rated frame current Inm(A)	约定发热电流Ith(A) Conventional thermal current Ith(A)	额定工作电流Ie(A) Rated working current	
			AC400V	DC220V
辅助触头 Auxiliary contact	≤225	3	0.3	0.15
	≥400	3	0.4	0.2
报警触头 Alarm contact	10≤Inm≤630	3	AC220V/1A	0.15

断路器的外部附件 The external accessories of the breaker

■ CD2L电动操作机构 CD2L motor-driven operation device

△ 电动机操作机构接线图（虚框内为电动机操作机构内部接线图）

Wiring diagram of motor-driven operation device (Internal wiring diagram of motor driven operation device in the dotted frame)

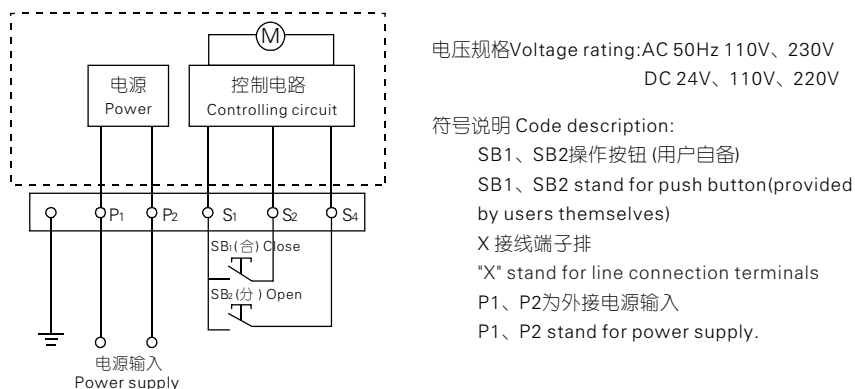

△ 电动操作机构的动作电源、电机功率及寿命见表

Action current, power and electrical life of the motor-driven operation device see following table.

配用断路器 Fitting breaker	动作电流(A) Action current(A)	电机功率(VA) Motor Power(VA)	寿命(次) Life(times)
GSL1-100	≤0.5	14	10000
GSL1-225	≤0.5	14	8000
GSL1-400	≤2	35	5000
GSL1-630	≤2	35	5000

△ 注(Note):

断路器脱扣跳闸后,电动操作机构必须先使断路器再扣,然后才能合闸。

Having released and tripped the breaker, the motor-driven operation device should make the breaker recamped first, then it could be turned on.

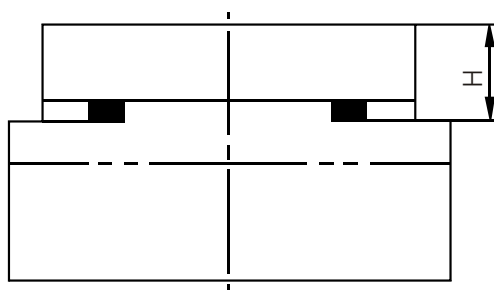

CD2电动操作机构
Type CD2 motor-driven
operation device

电动操作机构 Motor-driven operation device	配用断路器 Fitting breaker type	H(mm)
CD2-100	GSL1-100三、四极 GSL1-100 three、four poles	89.5
CD2-225	GSL1-225 GSL1-225 three、four poles	93
CD2-400	GSL1-400 GSL1-400 three、four poles	142
CD2-630	GSL1-630 GSL1-630 three、four poles	146

■ CS1转动手柄操作机构（三极及四极断路器通用）
CS1 turning handle operation device

△ 型号含义 Type and its meaning

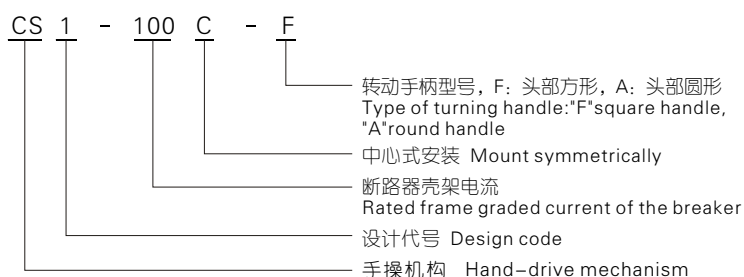

△ 特点: 该操作机构采用独特的设计和传动结构, 通过旋转手柄实现断路器的合闸、分闸和再扣。操作灵活、平稳, 操力小, 安装方便, 机构的整体性能和质量均优于其它同类产品。

Feature: Adopting the unique design and transmitting structure, the operation mechanism can make the breaker close, open and flexible operation, little force and convenient mounting, performance and quality of the device is better than other similar products.

△ 用途: 本机构专用于GSL1系列剩余电流动作断路器, 通过旋转手柄实现抽屉柜、配电柜、动力箱等在面板上操作的要求, 并保证断路器处于合闸时柜体门板不能开启(即与门联锁)。

Usage: The mechanism is used specially in GSL1 series residual current operated circuit-breaker, to operate the draw-out panel, power distribution panel and power supply box outside the panel by turning the handle, and to ensure the door of panel would not be opened when the breaker being on (i.e. Interlock with the door).

■ 外型及尺寸 Outline and dimensions

△ 配GSL1-100三极、四极的手操机构

The hand-drive mechanism of GSL1-100 three poles and four poles

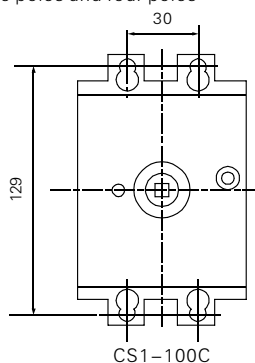

△ 配GSL1-225三极、四极的手操机构

The hand-drive mechanism of GSL1-225 three poles and four poles

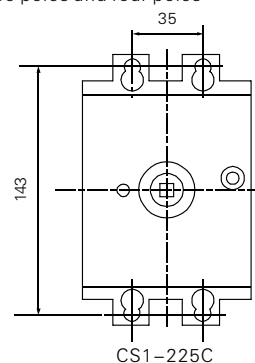

△ 配GSL1-400三极的手操机构

The hand-drive mechanism of GSL1-400 three poles

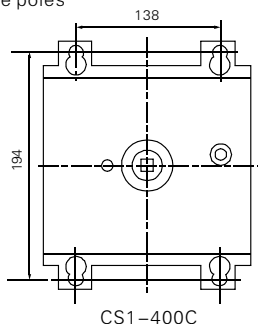

△ 配GSL1-400四极的手操机构

The hand-drive mechanism of GSL1-400 four poles

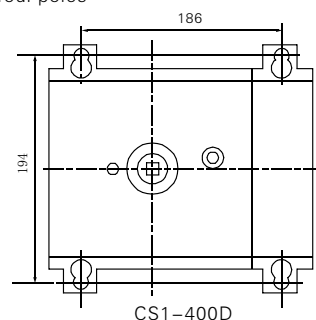

△ 配GSL1-630三极的手操机构

The hand-drive mechanism of GSL1-630 three poles

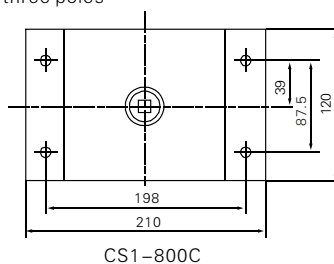

△ 配GSL1-630四极的手操机构

The hand-drive mechanism of GSL1-630 four poles

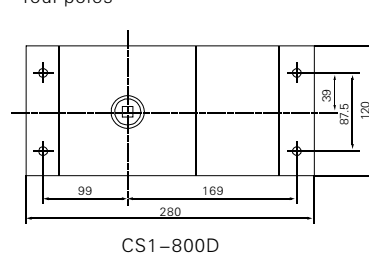

△ CS1系列手柄高度 Height of the hand-drive mechanism CS1 type

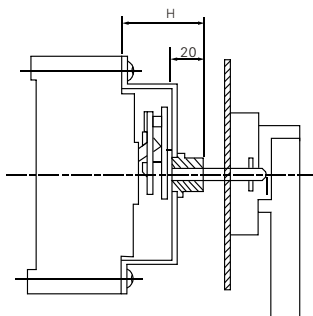

手操机构型号 Type of hand-drive mechanism	H(mm)
CS1 - 100/C	49
CS1 - 225/C	55
CS1 - 400/C、D	74
CS1 - 800/C、D	66

- △ CS1手操机构可配用二种操作手柄：一种为“F”型方形手柄；另一种为“A”型圆形手柄，其门板开孔尺寸见下图：

The hand-drive mechanism can be equipped with two types of operation handles: one is model "F" square handle, the other is model "A" round handle, Aperture dimension on the panel sheet see the following drawings.

■ 操作手柄特点：Characteristics of the operation handle:

- △ 当断路器在合闸状态时，不能开启柜门；

The panel door can't be opened when the breaker is closed.

- △ 若操作手柄或手操机构在合闸状态时有故障，可通过操作机构手柄上的紧急解锁装置开启柜门；

If fault happens while the operation handle or hand-drive mechanism is closed, the panel door can be opened by operating the emergency relievier on the operation handle.

- △ 对应不同规格的手操机构，相配套的手操手柄，其门板开孔一致。

For the operation handle fitting hand-drive mechanism of different specifications, the aperture on the panel sheet should be same.

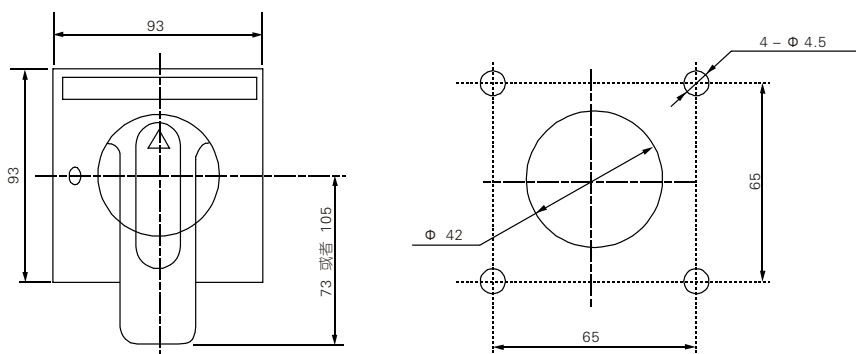

“F”型方形手柄外形及门板开孔尺寸（开孔中心离铰链距离不小于100mm）
Contour of model "F" square handle and the aperture dimension on the panel sheet (distance from the aperture center to hinge of panel door isn't less than 100mm).

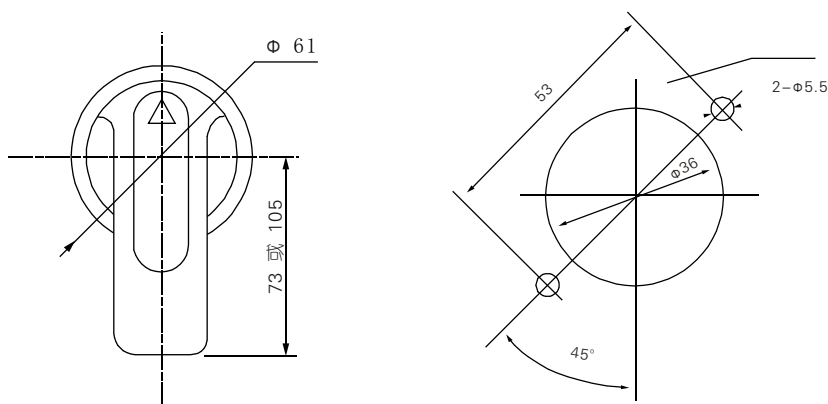

“A”型圆形手柄外形及门板开孔尺寸（开孔中心离铰链距离不小于100mm）
Contour of model "A" round handle and the aperture dimension on the panel sheet (distance from the aperture center to hinge of panel door isn't less than 100mm)

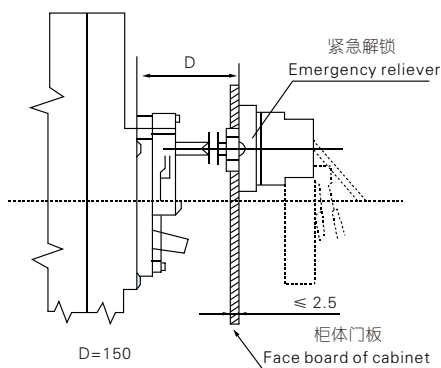

■ 注(Note):

- △ 方轴长度D=150，长度大于150mm时，在订货时注明；
Length of the square axis(D) is 150mm.In case of the length is more than 150mm,please note while making orders.
- △ 手操机构配用“F”型手柄，型号CS1加注“F”如CS1-100C-F即可；配用“ A”型手柄，型号加注“A”，如CS1-100C-A。
While hand-driv mechanism is equipped with model "F" handle ."F" would be

put together with "CS1", for example written in "CS1-100C-F". While operation handle is equipped with the model "A" handle, "A" must be added, for example written in "CS1-100C-A".

△ 警告用户:手动操作机构, 必须向本公司配套订货以确保产品质量。如用户自行购买, 安装装配后发生的一切不良后果本公司概不负责。

Advice users: To insure the quality, the hand-drive mechanism should be placed order with the for complete set with the breaker. If bought by yourselves, and harmful effects took place after mounted, the company would be not responsible for it.

十五、不同额定电流的连接导线参考截面 CROSS-SECTIONAL AREA OF WIRING CABLE AND CORRESPONDING RATED CURRENT

额定电流值(A) Rated current	16 20	25	32	40 50	63	80	100	125 140	160	180 200 225	250	315 350	400
导线截面面积(mm ²) Cross-sectional area of wire	2.5	4	6	10	16	25	35	50	70	95	120	185	240

额定电流值(A) Rated current	电缆 Cable		铜排 Copper bar	
	截面面积(mm ²) Cross-sectional area of wire	数量 Number	尺寸(mm × mm) Dimension	数量 Number
500	150	2	30	2
630	185	2	40	2

十六、接线端子型号 TYPE OF WIRING TERMINAL

△ 接线端子分JGC及JBC二种型号供用户选用

Two types of wiring terminals are supplied: JGC and JBC, chosen by users

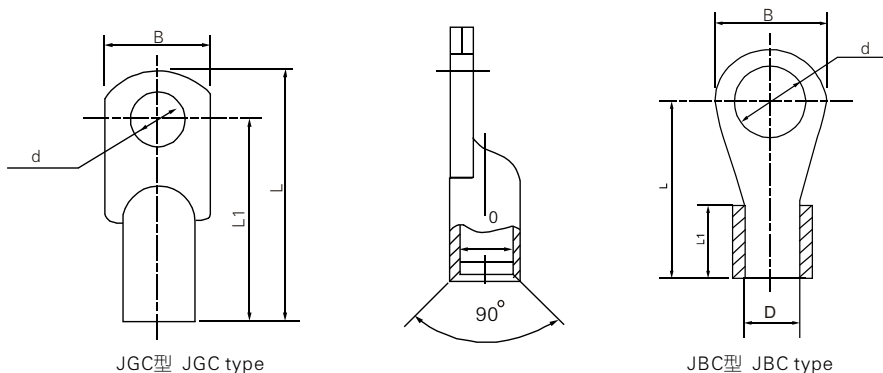

型号	电流(A)	导线截面面积(mm ²)	端子型号	B	L	L1	D	d
GSL-100	16、20	2.5	JBC2.5-8	15	24.5	8.5	Φ2.6	Φ8.2
	25、32	6	JBC6-8	15	24.5	10	Φ3.5	Φ8.2
	40、50	10	JBC10-8	15	24.5	11	Φ4.5	Φ8.2
	63	16	JGC16-8	12.5	41	3.5	Φ6	Φ8.2
	80	25	JGC25-8	14	46	8.5	Φ7	Φ8.2
	100	35	JGC35-8	15.5	52	44.5	Φ8	Φ8.2
GSL-225	125	50	JGC50-8	17	54	45	Φ10	Φ8.2
	140、160	70	JGC70-8	21.6	61	52	Φ11	Φ8.2
	180、200、225	95	JGC95-8	22	66	57	Φ13	Φ8.2

十七、注意事项 MATTERS NEEDING ATTENTION

- △ 断路器各种特性由制造厂整定，用户在使用中不可随意调整。
All the performance of the breaker have been set by the company, and it could not be adjusted arbitrarily in use.
- △ 断路器的额定剩余电流、剩余电流动作时间（非延时和延时），用户可以根据实际需要进行调整（专业人员进行）；
The rated residual working current and residual current working time (undelay and delay) of the breakers can be adjusted by the users according to actual needs (operated by professionals).
- △ 在主电路通电状态下，对额定剩余动作时间形式为非延时型的断路器，手按模拟剩余电流动作试验按钮应立即脱扣。对延时型，手按试验按钮且保持所调的延时时间值，断路器才脱扣；
As the main circuit is energized, For the rated residual working time of undelayed of the breaker, Press the button of simulating residual current working test should release immediately. For the delayed breaker, only while, press the test button and remain the adjusted delay time value, the breaker could release.
- △ 断路器漏电脱扣后，面板上漏电指示按钮向外凸出；
After the breaker released due to creepage, the creepage indicating button on the panel should be out-protrude.
- △ 带漏电报警单元模块的断路器，当发生漏电报警后，必须对模块上的复位按钮进行复位，断路器漏电保护模块才能正常工作；
The breaker with creepage alarm unit module must reset the return button when creepage alarmed, and the creepage protection module of the breaker can work as normal.

十八、订货须知 ORDERING NOTICE

- △ 用户务必确认对本产品技术资料已有了详细了解，并应根据断路器将来使用的场合，按“订货规范”表订货。
Users should sure of their detailed acquaintance of the products' technological materials and make order by the erdering notice in terms of future applicable situations of the circuit breakers.
- △ 如用户订货时，对产品的型式未作特殊说明本公司提供的均为延时型产品；对剩余电流保护参数不作要求，本公司按“剩余电流保护出厂整定值”表配置。
The campany would configure by "Factory's setting values of residual current protection" if users had no requirements of protection parameters of Residual current when making order.
- △ 三相四线400V/230V或单相与三相共用的线路，应选用四极断路器。
Four poles breakers for the share wire of three-phase four-wire 400V/230V or single phase and Three-phase.

十九、订货规范 ORDERING NOTICE

请在□内填上数值或打“√”

Please fill figures in □, mark √ in □

用户单位 User Name		订货总数 Order Amount		订货日期 Date	
型号 Type	GSL1 - □ □ □ / □ □ □ □				
额定电流 Rated current	In = □ A				
连接 Wiring	板前接线□ Wiring in front of the board	板后接线□ Wiring on back of the board	插入式接线□ Insertion type of the board		
额定剩余动作电流 rated residual working current	非延时型□ Undelay	100mA□	300mA□	500mA□	1000mA□
	延时型□ Delay	100mA□	300mA□	500mA□	1000mA□
额定剩余动作时间 Rated residual current working time	非延时型□ Undelay				
	延时型□ Delay	5IΔn时最大断开时间 0.25s□ 0.9s□ 1.9s□ Maximum breaking time of 5IΔn			
附件 Accessories	内部附件 Internal accessories	分励脱扣器 Shunt release	AC400V□ AC230V□ DC220V□		
		欠电压脱扣器 Under-voltage release	AC400V□ AC230V□		
		漏电报警单元模块 Creepage alarm unit module	AC400V□ AC230V□		
	外部附件 External accessories	电动机操作机构 Power-driven operation mechanism	AC230V□ AC110V□ DC220V□ DC110V□		
		转动手柄操作机构 Turning handle operation mechanism	CS1 - F□ CS1 - A□		

剩余电流保护出厂整定值

Factory's setting of residual current protection

型号 Type	GSL1-100	GSL1-225	GSL1-400	GSL1-630
额定剩余动作电流值 Rated residual working current	300mA	300mA	300mA	500mA
动作时间 Acting time	非延时型 Undelay	5IΔn最大断开时间为0.04s Maximum breaking time of 5IΔn is 0.04s		
	延时型 Delay	0.25s	0.25s	0.9s